

LED Tube

T8 LED Tube (c-UL-us)

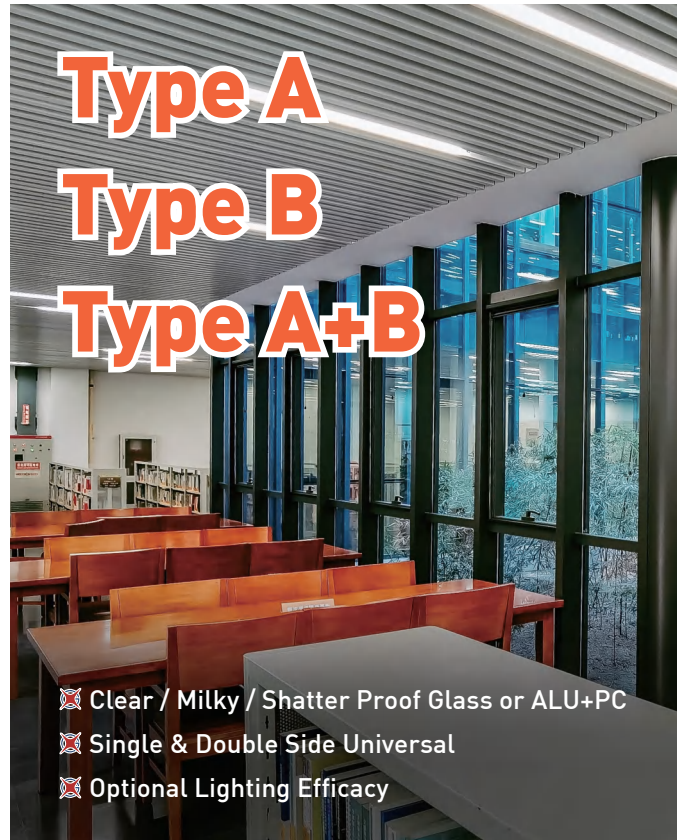

01



G13



Dimmable
Option



Ra80
90/97



50000h



U:120-277V



For Indoor



320°



>0.9

Model No. 产品规格	Dimension DxL(mm)	Rated Power 额定功率	Power EqV. 替换功率	Total Lumen 光通量	Color Temp. 色温	PCS/CTN 装箱数量	CTN MEAS. 装箱尺寸(cm)
NLT8B102P-E9-A	Φ26*590	Per Ballast~9W	17W	1300lm	3000K-5000K	25	62.5x17x17.5
NLT8B103P-E12-A	Φ26*895	Per Ballast~12W	30W	1500lm	3000K-5000K	25	93.5x17x17.5
NLT8B104P-E15/18-A	Φ26*1199	Per Ballast~15W/~18W	32W	1800lm/2150lm	3000K-5000K	25	123.5x17x17.5
NLT8B102P-E9-B	Φ26*590	9W	18W	1200lm	3000K-5000K	25	62.5x17x17.5
NLT8B103P-E12-B	Φ26*895	12W	30W	1450lm	3000K-5000K	25	93.5x17x17.5
NLT8B104P-E11/15/18-B	Φ26*1199	11W/15W/18W	32W	1450lm/1800lm/2150lm	3000K-5000K	25	123.5x17x17.5
NLT8B102P-E9-AB	Φ26*590	9W	17W	1350lm	3000K-5000K	25	62.5x17x17.5
NLT8B103P-E12-AB	Φ26*895	12W	30W	1450lm	3000K-5000K	25	93.5x17x17.5
NLT8B104P-E15/18-AB	Φ26*1199	15W	32W	1800lm/2000lm	3000K-5000K	25	123.5x17x17.5

☒ Rated Lume is base on DLC Certified Nominal Rating

LED Tube

T8 LED Glass Tube (Europe)



02

Features :

- ☒ Optional PC / NANO / ALU+PC Housing
- ☒ Optional End Caps
- ☒ Single Sided Input

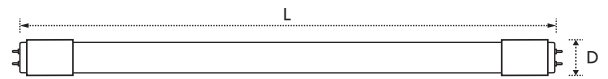

G13



No Flicker



Ra80
90/97



25000h



S:85-265V



For Indoor



320°

Model No. 产品规格	Dimension DxL(mm)	Rated Power 额定功率	Power EqV. 替换功率	Lumen Efficacy 光效	Color Temp. 色温	DF 位移因素	PCS/CTN 装箱数量	CTN MEAS. 装箱尺寸(cm)
XGYT8B102	Φ26*590	8W/9W	18W	100-210 lm/W	3000K-6500K	>0.7/0.9	25	62.5x17x17.5
XGYT8B103	Φ26*895	12W	30W	100-210 lm/W	3000K-6500K	>0.7/0.9	25	93.5x17x17.5
XGYT8B104	Φ26*1199	16W/18W	36W	105-210 lm/W	3000K-6500K	>0.7/0.9	25	123.5x17x17.5
XGYT8B105	Φ26*1499	22W/24W/28W	58W	100-210 lm/W	3000K-6500K	>0.7/0.9	25	153.5x17x17.5
XGYT8B106	Φ26*1764	32W	75W	100-210 lm/W	3000K-6500K	>0.7/0.9	25	184x17x17.5
XGYT8B108	Φ26*2374.3	36W	100W	100-210 lm/W	3000K-6500K	>0.7/0.9	25	250x17x17.5

☒ Lumen Efficacy is Customizable

LED Tube

T8 LED Glass Tube (Brazil / Latin America)



03

Brazil



Model No. 产品规格	Dimension DxL(mm)	Rated Power 额定功率	Power EqV. 替换功率	Lumen Efficacy 光效	Color Temp. 色温	PCS/CTN 装箱数量	CTN MEAS. 装箱尺寸(cm)
XGYT8B102	Φ26*590	9W	18W	95-105 lm/W	3000K-6500K	25	62.5x17x17.5
XGYT8B104	Φ26*1199	18W	36W	95-105 lm/W	3000K-6500K	25	93.5x17x17.5
XGYT8B108 XGYT8B208	Φ26*2374.3	40W	100W	95-105 lm/W	3000K-6500K	25	250x17x17.5

☒ Lumen Efficacy is Customizable

Latin America

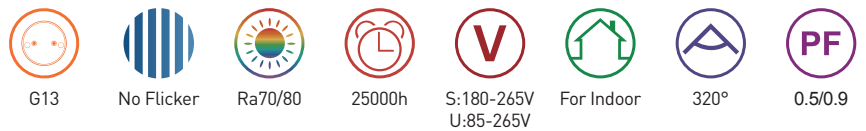

☒ Single or Double Side Input



Model No. 产品规格	Dimension DxL(mm)	Rated Power 额定功率	Power EqV. 替换功率	Lumen Efficacy 光效	Color Temp. 色温	PCS/CTN 装箱数量	CTN MEAS. 装箱尺寸(cm)
XGYT8B102	Φ26*590	9W	18W	80-160 lm/W	3000K-8000K	25	62.5x17x17.5
XGYT8B104	Φ26*1199	18W	36W	80-160 lm/W	3000K-8000K	25	123.5x17x17.5

☒ Lumen Efficacy is Customizable

LED Tube



T8 LED Glass Tube

(Eastern EU & South-East Asia & Africa / SASO & Middle East)



Eastern EU & South-East Asia & Africa

CE CB ErP



G13



No Flicker



Ra70/80



25000h



S:180-265V



For Indoor



320°



0.5/0.9

04

Model No. 产品规格	Dimension DxL(mm)	Rated Power 额定功率	Power EqV. 替换功率	Lumen Efficacy 光效	Color Temp. 色温	PCS/CTN 装箱数量	CTN MEAS. 装箱尺寸(cm)
XGYT8B102	Φ26*590	9W	18W	80-160 lm/W	3000K-8000K	25	62.5x17x17.5
XGYT8B103	Φ26*895	12W	30W	80-160 lm/W	3000K-8000K	25	93.5x17x17.5
XGYT8B104	Φ26*1199	18W	36W	80-160 lm/W	3000K-8000K	25	123.5x17x17.5
XGYT8B105	Φ26*1499	22W	58W	80-160 lm/W	3000K-8000K	25	153.5x17x17.5

Lumen Efficacy is Customizable

SASO & Middle East

SASO CB ErP



G13



No Flicker



Ra70/80



25000h



S:140-265V
U:85-265V



For Indoor



320°



0.5/0.9

Single or Double Side Input

SASO EER Rated (CRI 80)



Model No. 产品规格	Dimension DxL(mm)	Rated Power 额定功率	Power EqV. 替换功率	Lumen Efficacy 光效	Color Temp. 色温	PCS/CTN 装箱数量	CTN MEAS. 装箱尺寸(cm)
XGYT8B102	Φ26*590	12W/14W	18W	80-160 lm/W	3000K-8000K	25	62.5x17x17.5
XGYT8B104	Φ26*1199	24W/28W	36W	80-160 lm/W	3000K-8000K	25	123.5x17x17.5

Lumen Efficacy is Customizable

LED Tube

T8 LED ALU+PC Tube (General)



1.8/2.4m Available

05

Optional Rotatable Caps



G13

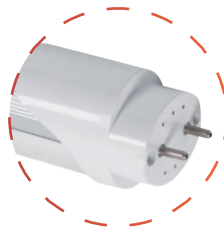

R17D



FA8



G13



No Flicker



Ra80
90/97



30000h



S:180-265V
U:85-265V



For Indoor



160°



0.5/0.9

Model No. 产品规格	Dimension DxL(mm)	Rated Power 额定功率	Power EqV. 替换功率	Lumen Efficacy 光效	Color Temp. 色温	PCS/CTN 装箱数量	CTN MEAS. 装箱尺寸(cm)
XGYT8B202	Φ26*590	9W/10W	18W	80-160 lm/W	3000K-8000K	25	63*20*20
XGYT8B203	Φ26*895	12W	30W	80-160 lm/W	3000K-8000K	25	94*20*20
XGYT8B204	Φ26*1199	18W/20W	36W	80-160 lm/W	3000K-8000K	25	124*20*20
XGYT8B205	Φ26*1499	22W/24W	58W	80-160 lm/W	3000K-8000K	25	154*20*20
XGYT8B206	Φ26*1764	32W	75W	80-160 lm/W	3000K-8000K	25	184*20*20
XGYT8B208	Φ26*2473	36-40W	100W	80-160 lm/W	3000K-8000K	25	242*20*20

☒ Lumen Efficacy is Customizable

LED Linear Fixtures

T8 Tubes & Fixtures in (Shrink-Packaging)



Features :

- ☒ Hot Seller in Supermarkets of South-East Asia (Thailand & Philippines)
- ☒ Easy to Setup by Direct Wiring to AC Supply
- ☒ Single End and Double End Power Input Available
- ☒ Reflector Model and Inter-connectable Model Available
- ☒ Simple and Appealing Packaging Style, Good Protection to Tubes

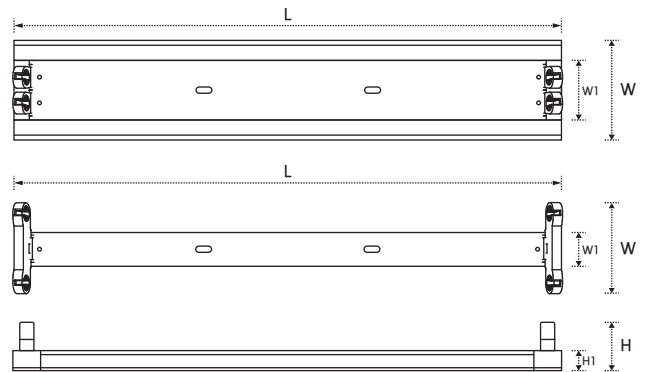

CB CE ErP 

V8 Tube Fixture

(Suitable For Magnetic Ballast)

Model No. 产品规格	Dimension LxWxH(mm)	Rated Power 额定功率	Thickness 金属厚度
XGY-T8-V820	600*50*63(28)	1*18W	0.25mm
XGY-T8-V830	900*50*63(28)	1*30W	0.25mm
XGY-T8-V840	1200*50*63(28)	1*36W	0.25mm
XGY-T8-DV820	600*83*63(28)	2*18W	0.25mm
XGY-T8-DV830	900*83*63(28)	2*30W	0.25mm
XGY-T8-DV840	1200*83*63(28)	2*36W	0.25mm

☒ Lamp Base Height: 35mm

V8 Tube Fixture + Reflector

(Suitable For Ballast)

Model No. 产品规格	Dimension LxWxH(mm)	Rated Power 额定功率	Thickness 金属厚度
XGY-T8-SZM6	600*125(50)*66(31)	1*18W	0.25mm
XGY-T8-SZM9	900*125(50)*66(31)	1*30W	0.25mm
XGY-T8-SZM12	1200*125(50)*66(31)	1*36W	0.25mm
XGY-T8-DZM6	600*163(83)*66(31)	2*18W	0.25mm
XGY-T8-DZM9	900*163(83)*66(31)	2*30W	0.25mm
XGY-T8-DZM12	1200*163(83)*66(31)	2*36W	0.25mm

☒ Lamp Base Height: 35mm



Single / Double Tube Fixture

(Suitable For Direct AC Input)



Model No. 产品规格	Dimension LxWxH(mm)	Rated Power 额定功率	Thickness 金属厚度
XGY-T8-SPM6	600*33*49(14)	1*18W	0.2mm
XGY-T8-SPM9	900*33*49(14)	1*30W	0.2mm
XGY-T8-SPM12	1200*33*49(14)	1*36W	0.2mm
XGY-T8-SPM15	1500*33*49(14)	1*58W	0.2mm
XGY-T8-SPM6F	600*74(33)*49(14)	2*18W	0.2mm
XGY-T8-SPM9F	900*74(33)*49(14)	2*30W	0.2mm
XGY-T8-SPM12F	1200*74(33)*49(14)	2*36W	0.2mm

☒ Lamp Base Height: 35mm

Cap Folding Single Tube Fixture

(Suitable For Direct AC Input)



Model No. 产品规格	Dimension LxWxH(mm)	Rated Power 额定功率	Thickness 金属厚度
XGY-T8-DPM6A	600*34*51(14)	1*18W	0.2mm
XGY-T8-DPM9A	900*34*51(14)	1*30W	0.2mm
XGY-T8-DPM12A	1200*34*51(14)	1*36W	0.2mm
XGY-T8-DPM6B	600*34*51(14)	1*18W	0.3mm
XGY-T8-DPM9B	900*34*51(14)	1*30W	0.3mm
XGY-T8-DPM12B	1200*34*51(14)	1*36W	0.3mm

☒ Lamp Base Height: 35mm

V3 Tube Fixture

(Suitable For Electronic Ballast)



Model No. 产品规格	Dimension LxWxH(mm)	Rated Power 额定功率	Thickness 金属厚度
XGY-T8-V320	600*40*59(24)	1*18W	0.3mm
XGY-T8-V330	900*40*59(24)	1*30W	0.3mm
XGY-T8-V340	1200*40*59(24)	1*36W	0.3mm
XGY-T8-V320A	600*40*59(24)	1*18W	0.25mm
XGY-T8-V330A	900*40*59(24)	1*30W	0.25mm
XGY-T8-V340A	1200*40*59(24)	1*36W	0.25mm
XGY-T8-V320FA	600*74(40)*59(24)	2*18W	0.25mm
XGY-T8-V330FA	900*74(40)*59(24)	2*30W	0.25mm
XGY-T8-V340FA	1200*74(40)*59(24)	2*36W	0.25mm

☒ Lamp Base Height: 35mm

V3 Tubes Fixture + Reflector

(Suitable For Electronic Ballast)



Model No. 产品规格	Dimension LxWxH(mm)	Rated Power 额定功率	Thickness 金属厚度
XGY-T8-V320AR	600*125(40)*59(24)	1*18W	0.25mm
XGY-T8-V330AR	900*125(40)*59(24)	1*30W	0.25mm
XGY-T8-V340AR	1200*125(40)*59(24)	1*36W	0.25mm
XGY-T8-V320FAR	600*125(40)*59(24)	2*18W	0.25mm
XGY-T8-V330FAR	900*125(40)*59(24)	2*30W	0.25mm
XGY-T8-V340FAR	1200*125(40)*59(24)	2*36W	0.25mm

☒ Lamp Base Height: 35mm

Inter-connectable Single Tube Fixture

(Suitable For Direct AC Input)



Model No. 产品规格	Dimension LxWxH(mm)	Rated Power 额定功率	Thickness 金属厚度
XGY-T8-SPM6A	600*33*49(14)	1*18W	0.2mm
XGY-T8-SPM9A	900*33*49(14)	1*30W	0.2mm
XGY-T8-SPM12A	1200*33*49(14)	1*36W	0.2mm

☒ Lamp Base Height: 35mm

Broad Base Double Tubes Fixture

(With or Without Reflector)



Model No. 产品规格	Dimension LxWxH(mm)	Rated Power 额定功率	Thickness 金属厚度
XGY-T8-OP6	600*83*66(31)	2*18W	0.3mm
XGY-T8-OP9	900*83*66(31)	2*30W	0.3mm
XGY-T8-OP12	1200*83*66(31)	2*36W	0.3mm
XGY-T8-OP6Z	600*163(31)*66(31)	2*18W	0.3mm
XGY-T8-OP9Z	900*163(31)*66(31)	2*30W	0.3mm
XGY-T8-OP12Z	1200*163(31)*66(31)	2x36W	0.3mm

☒ Lamp Base Height: 35mm

LED Tube

T5 LED Tubes (Internal Driver)



Features :

- ❑ High Quality SMD 2835 Chips of Optional Light Efficacy & CCT
- ❑ Internal Driver, Single or Double End Input No Light Flickering IC Driver
- ❑ High Transmission Glass & PC of Good Diffusion
- ❑ High Quality G5 Aluminum / PC Caps
- ❑ Lifetime of 25,000 Hrs. With 2 Years Warranty

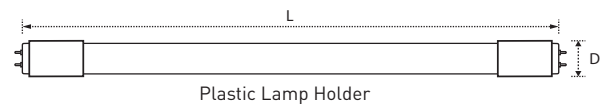
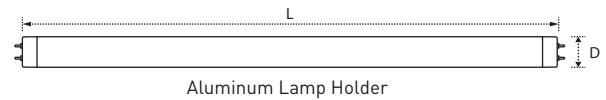

CE CB   ErP



G5



No Flicker



Ra80
90/97



25000h



S: 180-265V
U: 85-265V



For Indoor



320°

Model No. 产品规格	Dimension DxL(mm)	Rated Power 额定功率	Power EqV. 替换功率	Lumen Efficacy 光效	Color Temp. 色温	PCS/CTN 装箱数量	CTN MEAS. 装箱尺寸(cm)
XGYT5B3011D-E5	Φ16*288	5W	8W	80-160 lm/W	3000K-8000K	25	33.6*22.5*22.5
XGYT5B3021D-E9	Φ16*549	9W	14W	80-160 lm/W	3000K-8000K	25	59.6*22.5*22.5
XGYT5B3031D-E12	Φ16*849	12W	21W	80-160 lm/W	3000K-8000K	25	89.6*22.5*22.5
XGYT5B3041D-E18	Φ16*1149	18W	28W	80-160 lm/W	3000K-8000K	25	119.6*22.5*22.5
XGYT5B3051D-E22	Φ16*1449	22W	35W	80-160 lm/W	3000K-8000K	25	149.6*22.5*22.5

LED Tube



Smart T8 LED Tube (WIFI & Bluetooth Control)



09

APP:Tuya Smart



Mobile APP:

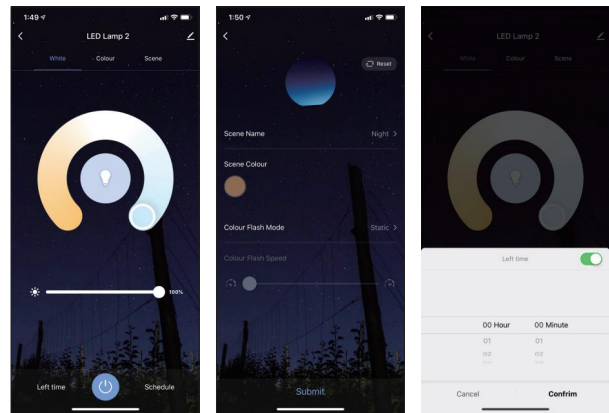

G13



No Flicker



Dimmable Option



Ra80 90/97



25000h



S:180-265V



For Indoor



320°



0.5

Model No. 产品规格	Dimension DxL(mm)	Rated Power 额定功率	Power EqV. 替换功率	Lumen Efficacy 光效	Color Temp. 色温	PCS/CTN 装箱数量	CTN MEAS. 装箱尺寸(cm)
XGYT8B102WFBT-E9	Φ26*590	9W	18W	80-160 lm/W	3000K-8000K	25	62.5*17*17.5
XGYT8B104WFBT-E18	Φ26*1199	18W	36W	80-160 lm/W	3000K-8000K	25	123.5*17*17.5
XGYT8B105WFBT-E22	Φ26*1499	22W	58W	80-160 lm/W	3000K-8000K	25	153.5*17*17.5

☒ Lumen Efficacy is Customizable

LED Tube

T8 Microwave Motion Detective LED Tube



10

Features :

- ☒ Recommended Installation height of 3-4.5m with sensor radius of 5-8m
- ☒ Triggered Instant Start with Customizable Sleep Time (Standard 45s, max 3 mins)
- ☒ Sleeping Brightness Customizable (Standard 3W, 1-10W Feasible)
- ☒ High Frequency Sensor Module of High Sensitivity to Human Body
- ☒ Sleeping Setting Allows Energy Saving up to 95%

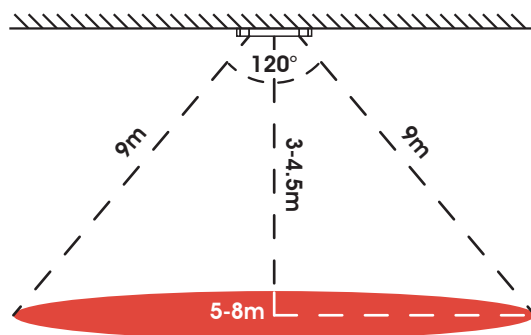

CE CB  ErP



G13



No Flicker



Ra70/80



25000h



S:180-265V
U:85-265V



For Indoor



320°



0.5/0.9

Model No. 产品规格	Dimension DxL(mm)	Rated Power 额定功率	Power EqV. 替换功率	Lumen Efficacy 光效	Color Temp. 色温	PCS/CTN 装箱数量	CTN MEAS. 装箱尺寸(cm)
XGYT8B102MS-E9	Φ26*590	9W	18W	80-160 lm/W	3000K-8000K	25	62.5*17*17.5
XGYT8B104MS-E18	Φ26*1199	18W	36W	80-160 lm/W	3000K-8000K	25	123.5*17*17.5
XGYT8B105MS-E22	Φ26*1499	22W	58W	80-160 lm/W	3000K-8000K	25	153.5*17*17.5

☒ Lumen Efficacy is Customizable

LED Tube

T8 Fresh Food Lighting LED Tube

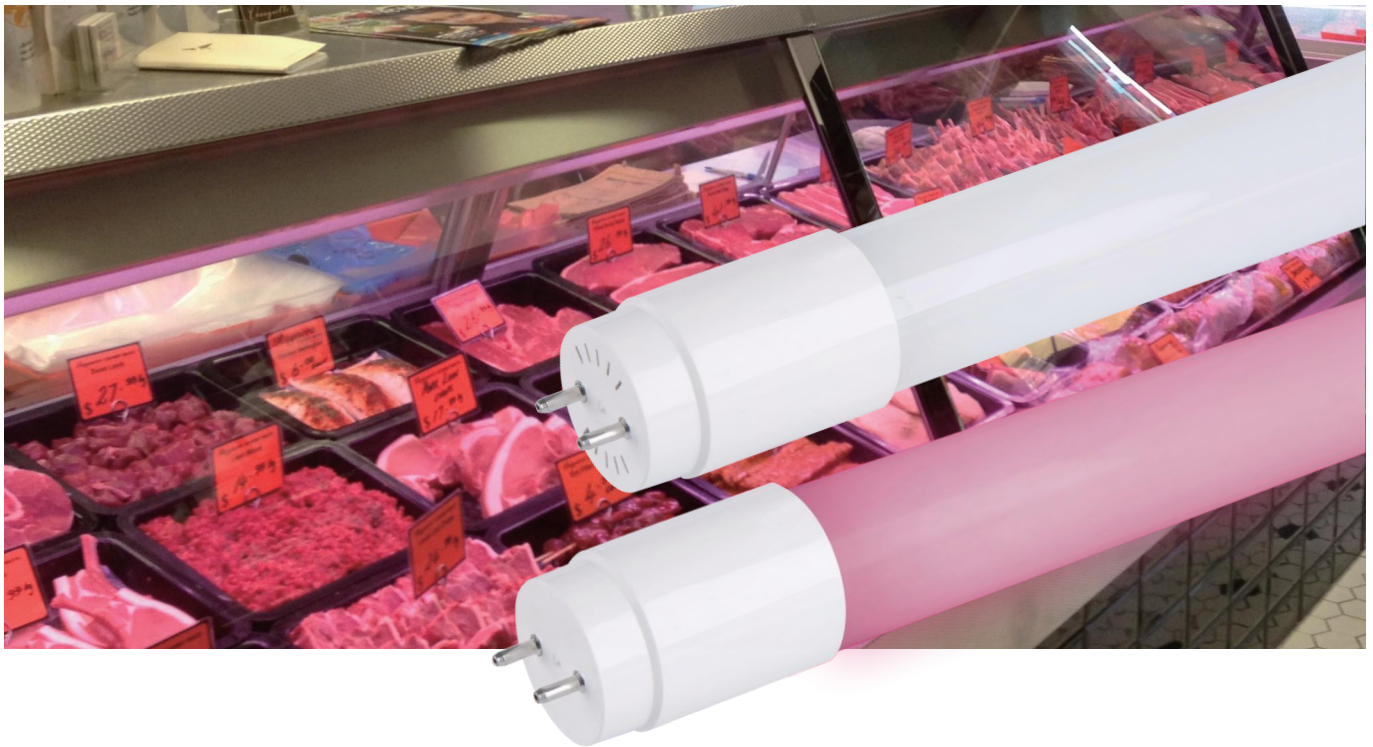

Features :

- ✘ Different Models for Fresh Meat, Fish, Vegetables and Bread
- ✘ Use High Quality LED Chips of Specific Light to Improve Color of Fresh Food
- ✘ Improved Color Rendering and Modified Spectrum to Visually Enhance Food Color
- ✘ Optional No Pin-Hole End Cap Design, Stands Low Temperature of Fridge

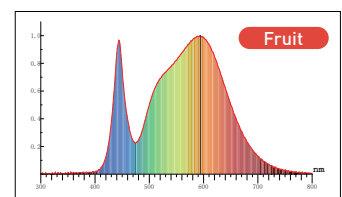
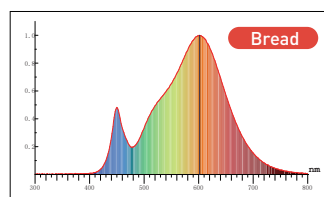
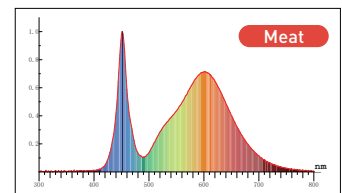
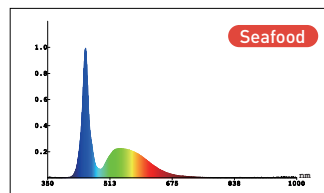

G13



No Flicker



Ra80
90/97



25000h



S:180-265V
U:85-265V



For Indoor



320°



0.5/0.9

Model No. 产品规格	Dimension DxL(mm)	Rated Power 额定功率	Power EqV. 替换功率	Lumen Efficacy 光效	PCS/CTN 装箱数量	CTN MEAS. 装箱尺寸(cm)
XGYT8B102FF-E9	Φ26*590	9W	18W	90-100 lm/W	25	62.5*17*17.5
XGYT8B103FF-E12	Φ26*895	12W	30W	90-100 lm/W	25	93.5*17*17.5
XGYT8B104FF-E18	Φ26*1199	18W	36W	90-100 lm/W	25	123.5*17*17.5
XGYT8B105FF-E22	Φ26*1499	22W	58W	90-100 lm/W	25	153.5*17*17.5

✘ Lumen Efficacy is Customizable

LED Tube

T8 Mosquito LED Tube



Clear Glass Body

12

Apply to



LED UVA Spectrum

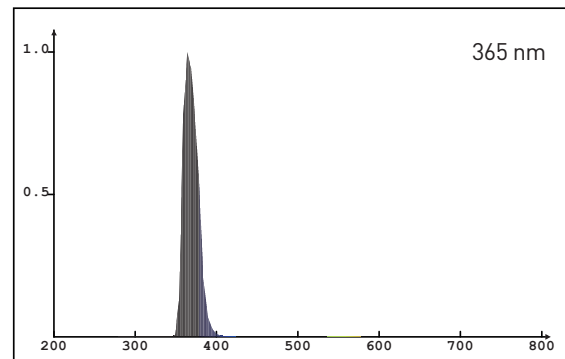

CE CB   ErP



G13



No Flicker



CRI UVA



25000h



S: 180-265V
U: 85-265V



For Indoor



320°



0.5/0.9

Model No. 产品规格	Dimension DxL(mm)	Rated Power 额定功率	Power Eqv. 替换功率	Lumen Efficacy 光效	Color Temp. 色温	PCS/CTN 装箱数量	CTN MEAS. 装箱尺寸(cm)
XGYT8B101UVA-E7	Φ26*331	7W	10W	UVA	UVA	25	36.5*17*17.5
XGYT8B102aUVA-E8	Φ26*437	8W	15W	UVA	UVA	25	47.5*17*17.5
XGYT8B102UVA-E9	Φ26*590	9W	18W	UVA	UVA	25	62.5*17*17.5
XGYT8B103UVA-E12	Φ26*895	12W	30W	UVA	UVA	25	93.5*17*17.5
XGYT8B104UVA-E18	Φ26*1199	18W	36W	UVA	UVA	25	123.5*17*17.5

LED Tube



T8 CCT adjustable LED Tube (Switching Control)



13

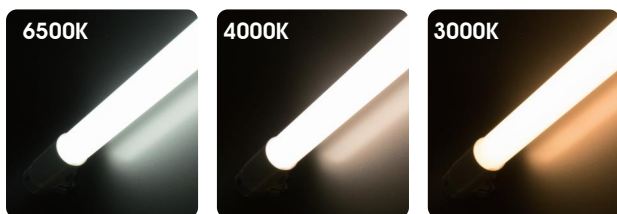

☒ Switch Control, CCT Controllable
Support 3000K | 4000K | 6500K 3 Color Temperatures

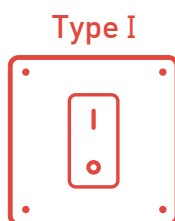

Home Switch
CCT Control

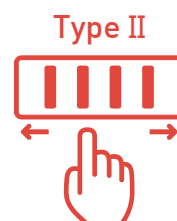

Slide Switch
CCT Control

CE CB ErP



G13



No Flicker



Ra80
90/97



25000h



S:180-265V



For Indoor



320°



0.5

Model No. 产品规格	Dimension DxL(mm)	Rated Power 额定功率	Power EqV. 替换功率	Lumen Efficacy 光效	Color Temp. 色温	PCS/CTN 装箱数量	CTN MEAS. 装箱尺寸(cm)
XGYT8B102CCT-E9 (3CCT)	Φ26*590	9W	18W	80-160 lm/W	3000K/4000K/6500K	25	62.5*17*17.5
XGYT8B104CCT-E18 (3CCT)	Φ26*1199	18W	36W	80-160 lm/W	3000K/4000K/6500K	25	123.5*17*17.5
XGYT8B105CCT-E22 (3CCT)	Φ26*1499	22W	58W	80-160 lm/W	3000K/4000K/6500K	25	153.5*17*17.5

☒ Lumen Efficacy is Customizable

LED Tube

T8 Dimmable LED Tube (Switching Control | Dimmer Control)



Switch Control Support 20% | 50% | 100%
3 level of brightness without dimmer.

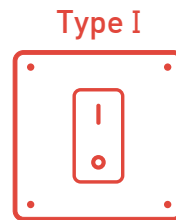

20% / 50% / 100%
Switching Control

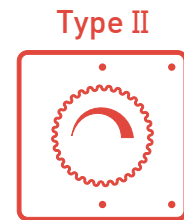

0-100%
Dimmer Control

CE CB   ErP



G13



No Flicker



Dimmable
Option



Ra80
90/97



25000h



S:180-265V



For Indoor



320°



0.5

Model No. 产品规格	Dimension DxL(mm)	Rated Power 额定功率	Power EqV. 替换功率	Lumen Efficacy 光效	Color Temp. 色温	PCS/CTN 装箱数量	CTN MEAS. 装箱尺寸(cm)
XGYT8B102DIM-E9 (SDIM)	Φ26*590	9W	18W	80-160 lm/W (0-100%) [20 50 100%]	3000K-8000K	25	62.5*17*17.5
XGYT8B104DIM-E18 (SDIM)	Φ26*1199	18W	36W	80-160 lm/W (0-100%) [20 50 100%]	3000K-8000K	25	123.5*17*17.5
XGYT8B105DIM-E22 (SDIM)	Φ26*1499	22W	58W	80-160 lm/W (0-100%) [20 50 100%]	3000K-8000K	25	153.5*17*17.5

⊗ Lumen Efficacy is Customizable

LED Tube

T8 360° Double-Sided LED Tube



15

Features :

- ☒ Double Sided Input to achieve 360° Beam Angle
- ☒ In-tube Aluminum Heat Sink to Improve Mechanical Strength & Reduce Light Decay
- ☒ High Power Output (1.2m 36W) & High Total Lumen
- ☒ Optional Water-proof End Caps to Achieve IP65 Protection
- ☒ Optional Anti-UV PC Body
- ☒ Single End Input, No Light Flickering IC Driver

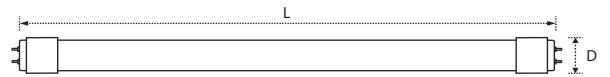

CE   ErP

 NOM 



G13



No Flicker



Ra80
90/97



25000h



S:180-265V
U: 85-265V



For Indoor



360°



0.5/0.9

Model No. 产品规格	Dimension DxL(mm)	Rated Power 额定功率	Power EqV. 替换功率	Lumen Efficacy 光效	Color Temp. 色温	PCS/CTN 装箱数量	CTN MEAS. 装箱尺寸(cm)
XGYT8B702DS-E18	Φ26*590	18W	18W	80-160 lm/W	3000K-8000K	25	62.5*17*17.5
XGYT8B704DS-E36	Φ26*1199	36W	36W	80-160 lm/W	3000K-8000K	25	123.5*17*17.5
XGYT8B705DS-E44	Φ26*1499	44-48W	58W	80-160 lm/W	3000K-8000K	25	153.5*17*17.5

☒ Lumen Efficacy is Customizable

LED Tube

T8 Waterproof LED Tubes (IP65)



Features :

- ☒ PG7 Water-proof PC End Caps to Achieve IP65 Protection Level
- ☒ Can Fit with Glass / PC / Nano Tubes
- ☒ Optional Connection Wire Length and Different Plugs
- ☒ Single End Input, No Light Flickering IC Driver
- ☒ Suitable for Damp Environment

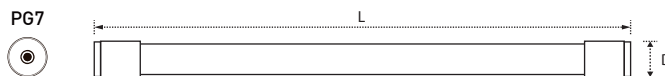

CE CB   ErP

 No Flicker

 Ra80

 25000h

 V
S:180-265V
U:85-265V

 For Outdoor

 320°

 PF
0.5/0.9

Model No. 产品规格	Dimension DxL(mm)	Rated Power 额定功率	Power EqV. 替换功率	Lumen Efficacy 光效	Color Temp. 色温	PCS/CTN 装箱数量	CTN MEAS. 装箱尺寸(cm)
XGYT8B102IP-E9 [XGYT8B70]	Φ26*590	9W	18W	80-160 lm/W	3000K-8000K	25	Cable Length Dependent
XGYT8B103IP-E12 [XGYT8B70]	Φ26*895	12W	30W	80-160 lm/W	3000K-8000K	25	Cable Length Dependent
XGYT8B104IP-E18 [XGYT8B70]	Φ26*1199	18W	36W	80-160 lm/W	3000K-8000K	25	Cable Length Dependent
XGYT8B105IP-E22 [XGYT8B70]	Φ26*1499	22W	58W	80-160 lm/W	3000K-8000K	25	Cable Length Dependent

☒ Lumen Efficacy is Customizable

LED Tube

T8 Emergency Lighting LED Tube



- ✘ Glass Tube Use an External Emergency Driver of Dimension 190(L)*40(W)*30(H)mm of V-0 Housing
 - External Battery Fully Charged in 24 Hrs. Support Emergency For 90(24W)-120 (20W) mins
 - External NI-CD Battery Output at DC 12V with Charging Capacity of 4000mAh
- ✘ Aluminum Tube could Work with Internal Battery & Driver
 - Internal Battery Fully Charged in 8 Hrs. Support Emergency For 60 (3W) mins
 - Internal NI-CD Battery Output at DC 3.7V with Charging Capacity of 1400mAh
- ✘ Emergency Backed Lighting Efficacy Can Be Customized (20-90%)



Glass Emergency Lighting

Model No. 产品规格	Dimension DxL(mm)	Rated Power 额定功率	Power EqV. 替换功率	Lumen Efficacy 光效	Color Temp. 色温	PCS/CTN 装箱数量	CTN MEAS. 装箱尺寸(cm)
XGYT8B102EL-E9 (External Driver & Battery)	Φ26*590	9W	18W	80-160 lm/W	3000K-8000K	25	62.5*17*17.5
XGYT8B103EL-E12 (External Driver & Battery)	Φ26*895	12W	30W	80-160 lm/W	3000K-8000K	25	93.5*17*17.5
XGYT8B104EL-E18 (External Driver & Battery)	Φ26*1199	18W	36W	80-160 lm/W	3000K-8000K	25	123.5*17*17.5
XGYT8B105EL-E22 (External Driver & Battery)	Φ26*1499	22W	58W	80-160 lm/W	3000K-8000K	25	153.5*17*17.5

✘ Lumen Efficacy is Customizable

ALU+PC Emergency Lighting

Model No. 产品规格	Dimension DxL(mm)	Rated Power 额定功率	Power EqV. 替换功率	Lumen Efficacy 光效	Color Temp. 色温	PCS/CTN 装箱数量	CTN MEAS. 装箱尺寸(cm)
XGYT8B202EL-E9 (Internal Driver & Battery)	Φ26*590	9W	18W	80-160 lm/W	3000K-8000K	25	63*20*19.5
XGYT8B203EL-E12 (Internal Driver & Battery)	Φ26*895	12W	30W	80-160 lm/W	3000K-8000K	25	94*20*19.5
XGYT8B204EL-E18 (Internal Driver & Battery)	Φ26*1199	18W	36W	80-160 lm/W	3000K-8000K	25	124*20*19.5
XGYT8B205EL-E22 (Internal Driver & Battery)	Φ26*1499	22W	58W	80-160 lm/W	3000K-8000K	25	154*20*19.5

✘ Lumen Efficacy is Customizable

LED Tube

T10 LED Fishing Boat Tubes (IP65)







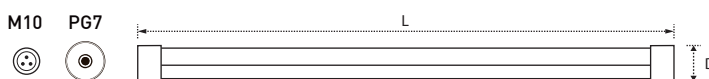

18

Features :

- ☒ Arrow to Arrow Fit
- ☒ M10 Male & Female Connectors
- ☒ Maximum 3 Lamps Interconnected
- ☒ IP65 Rating
- ☒ Safe Voltage Output Range: AC/DC12-24V



CB CE ErP 

						
No Flicker	Ra70/80	25000h	Input:U 85-265V Output:DC 12-24V	For Indoor	160°	0.5

Model No. 产品规格	Dimension DxL(mm)	Rated Power 额定功率	Interconnection 串接	Lumen Efficacy 光效	Color Temp. 色温	PCS/CTN 装箱数量	CTN MEAS. 装箱尺寸(cm)
XGYFBL-S-T10B7350-E10 (IP65)	Φ36*350	10W	Not Inter-connectable	80-130 lm/W	3000K-8000K	25	47*24.5*25
XGYFBL-S-T10B7550-E20 (IP65)	Φ36*550	20W	Not Inter-connectable	80-130 lm/W	3000K-8000K	25	67*24.5*25
XGYFBL-S-T10B7750-E30 (IP65)	Φ36*750	30W	Not Inter-connectable	80-130 lm/W	3000K-8000K	25	87*24.5*25
XGYFBL-M-T10B7350-E10 (IP65)	Φ36*350	10W	Inter-connectable	80-130 lm/W	3000K-8000K	25	47*24.5*25
XGYFBL-M-T10B7550-E20 (IP65)	Φ36*550	20W	Inter-connectable	80-130 lm/W	3000K-8000K	25	67*24.5*25
XGYFBL-M-T10B7750-E30 (IP65)	Φ36*750	30W	Inter-connectable	80-130 lm/W	3000K-8000K	25	87*24.5*25

☒ Lumen Efficacy is Customizable

LED Tube

LED H-shaped Tube



19

Features :

- ☒ Plug & Play Fluorescent Replacement
- ☒ Direct AC Model Available

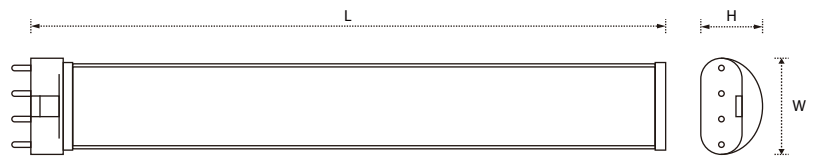

CB CE ErP 



No Flicker



Ra70/80



25000h



U: 100-240V



For Indoor



160°



0.9

Model No. 产品规格	Dimension WxHxL(mm)	Rated Power 额定功率	Power EqV. 替换功率	Lumen Efficacy 光效	Color Temp. 色温	PCS/CTN 装箱数量	CTN MEAS. 装箱尺寸(cm)
XGYHT202-E10	43*29*220	10W	18W	80-130 lm/W	3000K-6500K	25	24.7*23.5*17
XGYHT202-E12	43*29*315	12W	24W	80-130 lm/W	3000K-6500K	25	34.2*23.5*17
XGYHT202-E15	43*29*410	15W	36W	80-130 lm/W	3000K-6500K	25	43.7*23.5*17
XGYHT202-E18	43*29*535	18W	40W/50W	80-130 lm/W	3000K-6500K	25	56.2*23.5*17
XGYHT202-E20	43*29*565	20W	80W	80-130 lm/W	3000K-6500K	25	59.2*23.5*17

☒ Lumen Efficacy is Customizable

LED Tube

LED T9 Circular Lamp



20

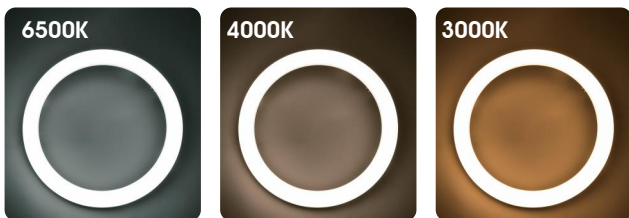

Switch Control, CCT Controllable
Support 3000K | 4000K | 6500K 3 Color Temperatures

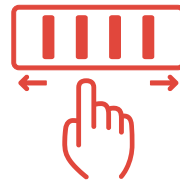

Slide Switch
CCT Control

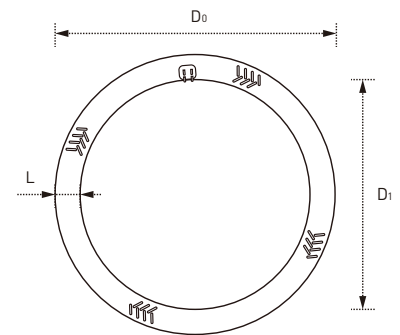

CB CE ErP 



No Flicker



Ra70/80



25000h



S: 180-265V
U: 85-265V



For Indoor



110°



0.5/0.9

Model No. 产品规格	Dimension LxDxD _i (mm)	Rated Power 额定功率	Power EqV. 替换功率	Lumen Efficacy 光效	Color Temp. 色温	PCS/CTN 装箱数量	CTN MEAS. 装箱尺寸(cm)
XGYT9-LCIR-E9 [D3CCT]	Φ30*225*165	9W	30W	100-160 lm/W	3000K-6500K (3000K/4000K/6500K)	10	24.5*38*25.5
XGYT9-LCIR-E12 [D3CCT]	Φ30*298*238	12W	32W	100-160 lm/W	3000K-6500K (3000K/4000K/6500K)	10	31.6*38*32.8
XGYT9-LCIR-E16 [D3CCT]	Φ30*373*313	16W	40W	100-160 lm/W	3000K-6500K (3000K/4000K/6500K)	10	39.1*38*40.3

☒ Lumen Efficacy is Customizable

Tube Material

Body Material

B10 = Glass Body + PC Caps

B20 = ALU Housing + PC Cover

B30 = Glass Body + Alu Caps

B40 = Clear Glass

B50 = Glass with Shatterproof Film

B70 = PC Body

B80 = Nano Body



Glass Body



ALU Housing



Clear Glass



Shatterproof Film



PC Body



Nano Body

21

Cap Option

PC Cover



G13R (Rotatable)



G13



R17D



FA8

PC Caps



PC (Long)



PC (Standard)



PC (Short)

Alu Caps



Alu (Short)



Alu (Stair Short)



Alu (Stair Long)

Circuit Diagram

US Standard

Type B-Single Ended Input



Type B-Double Ended Input

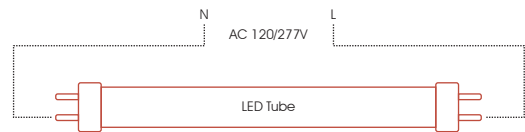

Type A

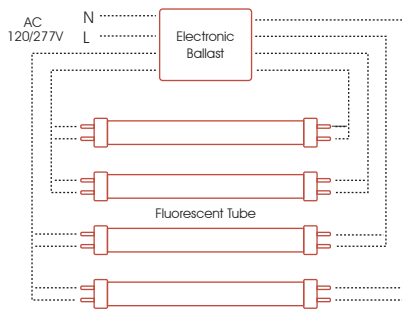

※ Before

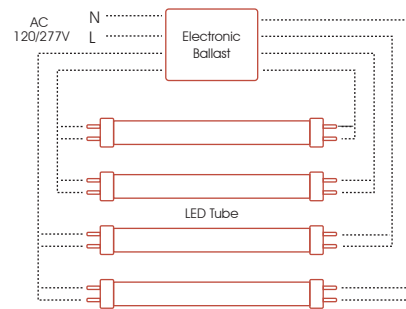

※ After

EU Standard

Single Ended Input

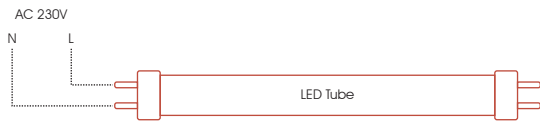

Double Ended Input

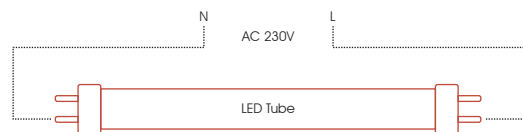

Ballast Compatible

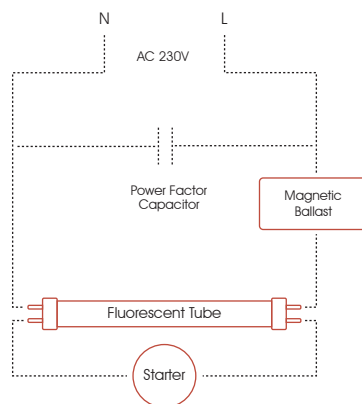

※ Before

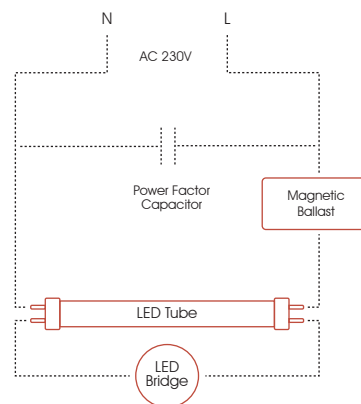

※ After